



ELSEVIER



Available online at www.sciencedirect.com

ScienceDirect

Procedia Engineering 100 (2015) 1182 – 1191

**Procedia
Engineering**

www.elsevier.com/locate/procedia

25th DAAAM International Symposium on Intelligent Manufacturing and Automation, DAAAM
2014

Simulation Models for Various Neutral Earthing Methods in Medium Voltage Systems

S. Ravlić^a, A. Marušić^b

^a*Ravel d.o.o., Brajkovićevo prilaz 13, Zagreb, 10020, Croatia*

^b*Faculty of Electrical Engineering and Computing, Unska 3, 10000, Zagreb*

Abstract

This paper describes simulation model of real network with various neutral earthing methods when a single pole earth fault occurs. Model was made using Matlab. The aim of the paper is to analyse values of the currents and of the temporary overvoltages with power frequency in case of a single pole earth fault.

The currents of single phase to ground faults depend (along with the neutral earthing method) mostly on the earth capacitances of the overhead lines or cables connected to the network. A comparison of the network with a large number of long cables and network with mostly overhead lines was made with the purpose to determine their influence.

With the intention to control results given by simulation models the mathematical model was created as well. The comparison of the simulation model results and calculated values show match. Simulation models are powerful analysis tools used to validate different solutions of neutral point earthing.

© 2015 The Authors. Published by Elsevier Ltd. This is an open access article under the CC BY-NC-ND license (<http://creativecommons.org/licenses/by-nc-nd/4.0/>).

Peer-review under responsibility of DAAAM International Vienna

Keywords: neutral earthing method; Peterson coil; single pole fault with earth; simulation model; medium voltage system

* Corresponding author. Tel.: +385-655-3628; fax: +385-654-7649.
E-mail address: sonja.ravlic@ravel.hr

1. Introduction

Single phase to earth faults are the most frequent failures in medium and high voltage systems [1]. The values of the currents and of the temporary overvoltages with power frequency in case of a single pole earth fault depend on the neutral point treatment, earth capacitances of the overhead lines or cables connected to the network, voltage level, the value of fault resistance and on the distance between the supply busbars and the fault location. Typically, medium voltage networks in Croatia are held isolated due to the superiority of isolated networks in terms of availability. With the increase of underground cable share in the overall medium voltage network's length, the capacitive earth-fault currents exceed permissive thresholds imposed by national regulations, therefore earthing of networks becomes imperative [4]. In the middle voltage networks in Croatia there are four methods of transformer neutral point grounding treatment: isolated neutral point, low-ohmic grounded neutral point, resonant grounded neutral point and partial compensation. Each concept has certain advantages and disadvantages that need to be taken into account for specific substation [5].

In order to describe the behaviour of the network during single phase earth faults simulation model was made using MATLAB SimPowerSystem software. SimPowerSystems provides component libraries and analysis tools for modelling and simulating electrical power systems [3]. The simulation model was made for all four methods of transformer neutral point grounding treatment. The model described in this paper observes substation during fault and the influence of various neutral earthing methods combined with the influence of the length of middle voltage power lines. The aim of the study is to show influence various neutral earthing methods and different length and type of the middle voltage power lines have on overvoltages and fault current magnitudes. Temporary overvoltages are dangerous because they can cause an insulation failure. Touch voltages depend directly on the value of fault current. With the increase of the fault current touch voltages increase, too. Technical regulations determine maximal values of dangerous touch voltage that can occur in and around of substation [1]. This model shows current and voltage conditions in the network during fault and can help at the decision which neutral grounding method to choose for specific substation [5].

Nomenclature

I_{k1}	- single pole fault current, A
U_n	- rated voltage, kV
X_C	- capacitive resistance, Ω
Z_{FAULT}	- fault impedance, Ω
R_E	- earthing resistance, Ω
X_L	- inductance impedance, Ω
R_{le}	- phase - to - ground resistance of the system, Ω
C_e	- earth capacitances of the overhead line or cable, $\mu\text{F}/\text{km}$

2. SimPowerSystems simulation models

Model network is shown in Fig. 1. In the same network four neutral earthing methods were applied. A simulation model consists of: three-phase 110 kV source, network transformer 110/36,75/10,5 kV, middle voltage cables and overhead lines, 35/21 kV transformers, 21/0,4 kV transformers, low voltage cables and the series lead.

The three-phase source is connected in Y with a grounded neutral. This block generates a three-phase sinusoidal 110 kV voltage.

Network transformer was modelled according to the real network transformer. Network transformers is 110/36,75/10,5 kV, 40 MVA with winding connection YNynD5.

Single pole fault with earth is represented as one-phase circuit breaker connected to ground. In series with circuit breaker is resistance (characterizes the ground resistance) [14].

All cables and overhead lines are represented as distributed parameter lines with different resistance, inductance and capacitance per unit length. Depending on the length and type of power line two cases are considered. Case A

includes mostly overhead lines (overhead lines/cable ratio is 3/1) and case B a large number of long cables. Parameters in case A and case B are given in Table 1 [11].

Table 1 Parameters of overhead lines and cables for case A and case B.

Rated voltage: 35 kV		Case A		Case B	
Power line type	Power line length [km]	Earth capacitances C_e [F]	Power line length [km]	Earth capacitances C_e [F]	
Overhead line	3	$3,065 \cdot 10^{-9}$	-	-	
Cable	1	$0,329 \cdot 10^{-6}$	40	$0,329 \cdot 10^{-6}$	

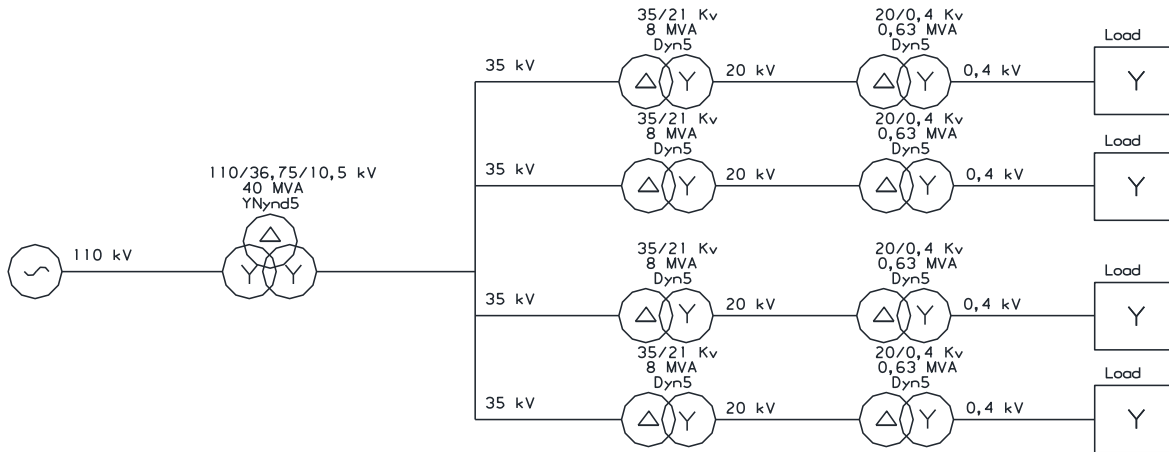

Fig. 1. The network model in Matlab SymPowerSystems.

3. Simulation expectations

Type and length of the middle voltage power lines and neutral earthing method should determine the earth fault current and overvoltages [2].

In all simulations the voltage of the faulted phase should collapse while the voltage on the other two phases should rise. Phase to phase voltages of all three phases before and after fault in all simulations should remain unchanged.

It is expected that currents in the case of the isolated neutral point increase significantly with the increase of the length of middle voltage cables. Internal overvoltages during earth faults are expected to be the highest in the case of the isolated neutral point (compared to all other neutral earthing methods).

In case of the low-ohmic neutral point large number of long cables should increase the value of the earth fault current. Earth fault currents are expected to be the highest in the case of low-ohmic neutral point (current increases especially with the increase of underground cables). Overvoltages in this case are expected to be the lowest.

In case of resonant grounded neutral point the inductive reactance of the Peterson coil is set near the value of the capacitive reactance of the whole network [9]. The capacitive and inductive currents are opposite and resulting current is expected to be very small. In the simulation, it is expected that result current is set to zero. Increase of the length of the underground cables should not influence the value of the current. Overvoltages in case of resonant grounded neutral point are expected to be very high (almost as high as in the case of an isolated neutral point) [10].

Increase of the length of the underground cables should not influence the value of the current in case of the partial compensation, too. Current is supposed to depend on the value of the low-ohmic resistor. Overvoltages in case of partial compensated networks should be similar as in the case of low-ohmic neutral point.

4. SimPowerSystems simulation models results

As expected, during a single phase earth fault the voltage of the faulted phase collapses while the voltage of the healthy phases rises. Fig. 2 shows the voltage of the faulted phase for all four methods of transformer neutral point earthing. A fault occurs 0,01 s after the beginning of the simulation [6].

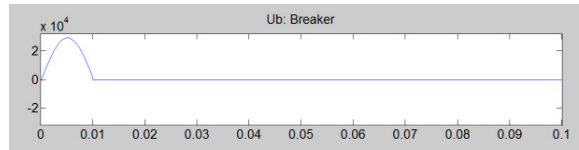

Fig. 2. Voltage of the faulted phase before and after the fault.

Phase to phase voltage of all three phases for all four methods of transformer neutral point grounding treatment remains unaffected. Fig. 3 shows phase to phase voltage for isolated neutral point in case A.

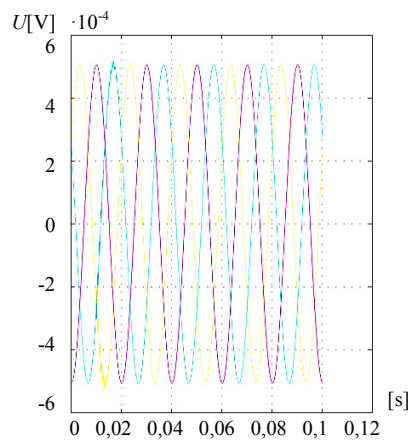

Fig. 3. Phase to phase voltage of all three phases before and after fault, isolated neutral point, case A.

4.1. Isolated neutral point

Fig. 4 shows fault current for isolated neutral point in case A. Fig. 5 shows fault current for isolated neutral point in case B. It is evident that fault current in case B is 42 times higher than in case A. Overvoltages in case A and case B are shown in Fig. 6.

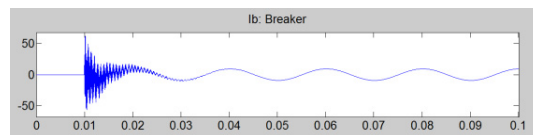

Fig. 4. Earth fault current in case of isolated neutral point, case A.

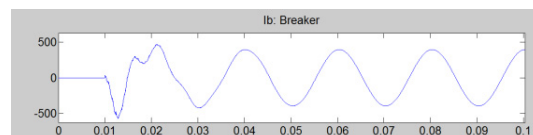

Fig. 5. Earth fault current in case of isolated neutral point, case B.

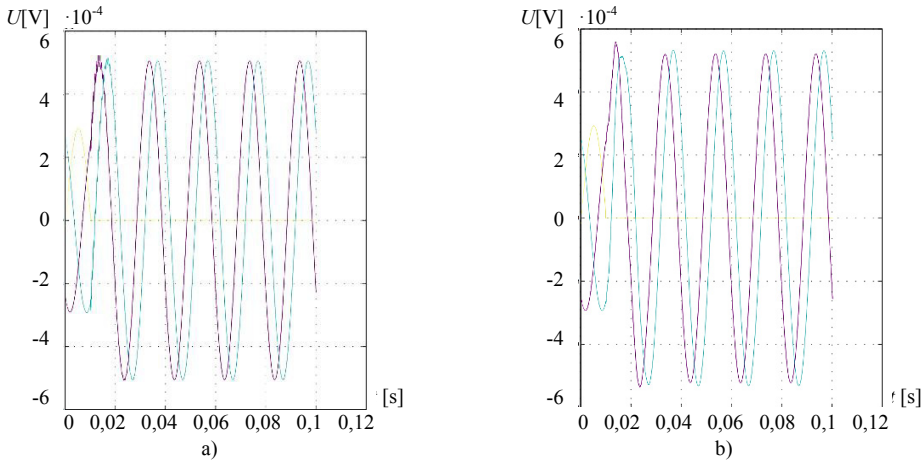

Fig. 6. Phase to ground voltage in case of isolated neutral: a) case A; b) case B.

4.2. Low-ohmic grounded neutral point

Fault current in case of low-ohmic grounded neutral point in case A is shown in Fig. 7. Fig. 8 shows fault current in case of low-ohmic grounded neutral point in case B. Overvoltages in case A and case B are given in Fig. 9.

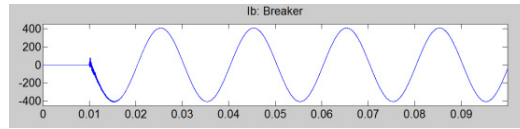

Fig. 7. Earth fault current in case of low-ohmic grounded neutral point, case A.

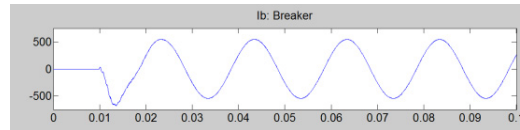

Fig. 8. Earth fault current in case of low-ohmic grounded neutral point, case B.

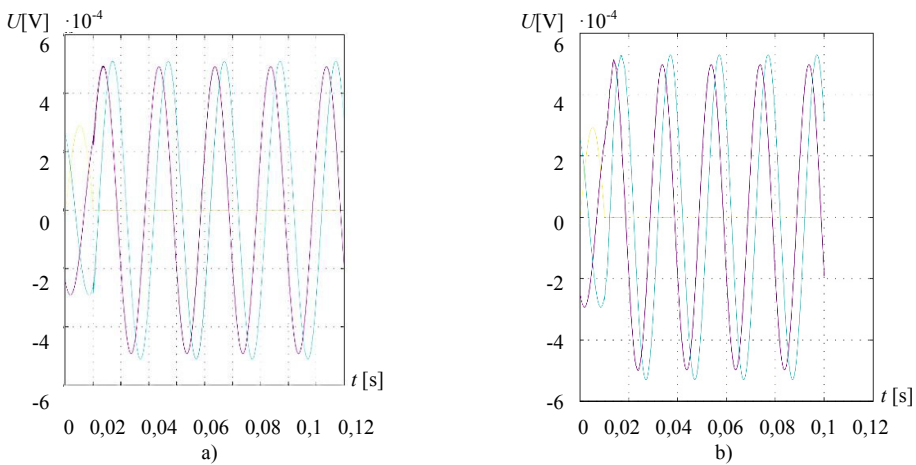

Fig. 9. Phase to ground voltage in case of low-ohmic grounded neutral point: a) case A; b) case B.

4.3. Resonant grounded neutral point

In case of resonant grounded neutral point fault current for case A are shown in Fig. 10 and in case B in Fig. 11. Overvoltages in case A and case B are shown in Fig. 12.

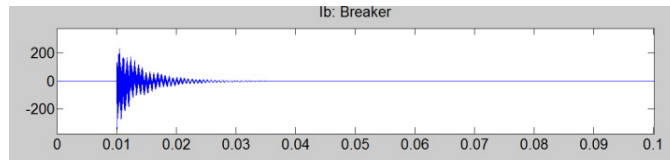

Fig. 10. Earth fault current in case of resonant grounded neutral point, case A.

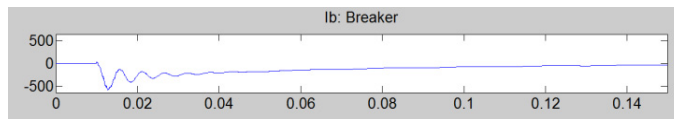

Fig. 11. Earth fault current in case of resonant grounded neutral point, case B.

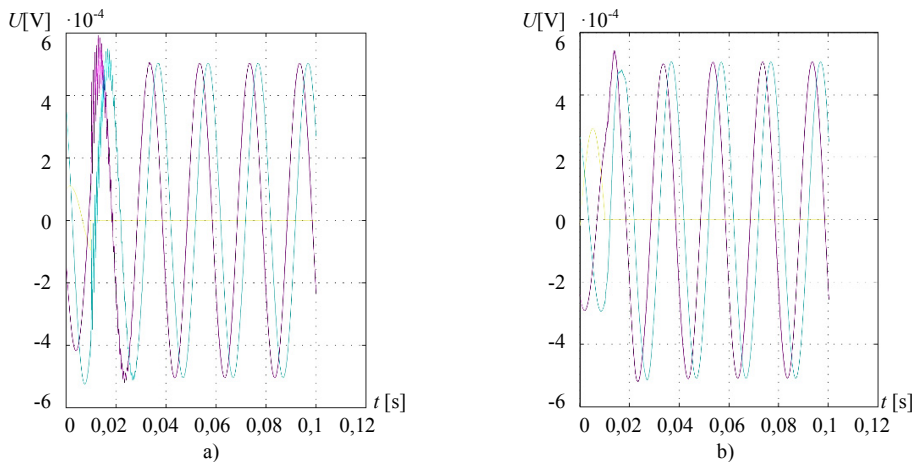

Fig. 12. Phase to ground voltage in case of resonant grounded neutral point: a) case A; b) case B.

4.4. Partial compensation

Fault currents in case of partial compensation are shown in Fig. 13 (case A) and in Fig. 14 (case B). Overvoltages in case A and case B are shown in Fig. 15.

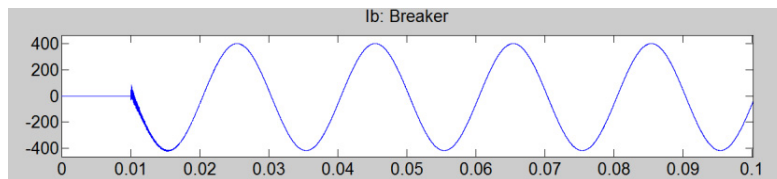

Fig. 13. Earth fault current in case of partial compensation, case A.

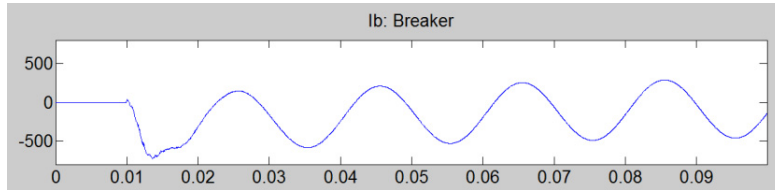

Fig. 14. Earth fault current in case of partial compensation, case B.

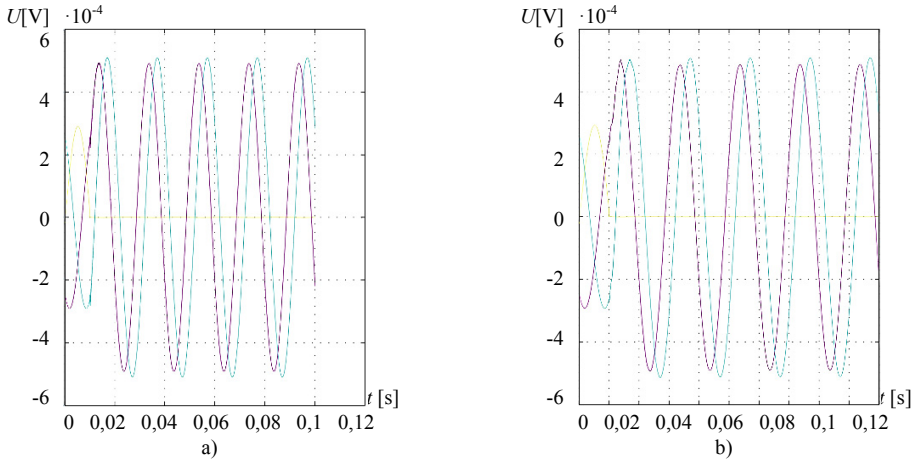

Fig. 15 Phase to ground voltage in case of partial compensation: a) case A; b) case B.

5. Mathematical models

With the intention to control results given by simulation models the mathematical model that describes networks with various neutral earthing methods when a single pole fault with earth occurs was created [7].

5.1. Isolated neutral point

Using formulas 1 and 2 for the network shown in Fig. 1 the values given in table 2 were calculated. Table 2 also gives comparison of simulated and calculated results.

$$I_{k1} = \frac{U_n}{\sqrt{3} \cdot \sqrt{\left(\frac{1}{X_c}\right)^2 + (Z_{FAULT})^2}} \tag{1}$$

$$Overvoltage = \frac{\sqrt{3}}{\sqrt{(1)^2 + (X_c \cdot Z_{FAULT})^2}} \tag{2}$$

Table 2 Simulated and calculated results in case of isolated neutral point.

Results	Case A		Case B	
	Simulated	Calculated	Simulated	Calculated
I_{k1} [A]	6,5761	6,57815	278,05	258,598
Overvoltage	1,7333	1,73205	1,7806	1,73205

5.2. Low-ohmic grounded neutral point

In case of low-ohmic grounded neutral point earthing resistance R_E needs to be taken into account, as well. Formulas 3 and 4 describe single pole fault current and overvoltages in networks with low-ohmic grounded neutral point when single pole fault with earth occurs. Table 3 shows simulated and calculated results in case of low-ohmic grounded neutral point.

$$I_{k1} = \frac{U_n \cdot \sqrt{(1)^2 + (X_c \cdot R_E)^2}}{\sqrt{3} \cdot \sqrt{(Z_{FAULT} + R_E)^2 + (Z_{FAULT} \cdot X_c \cdot R_E)^2}} \quad (3)$$

$$\text{Overvoltage} = \frac{\sqrt{3} \cdot \sqrt{(1)^2 + (X_c \cdot R_E)^2}}{\sqrt{(Z_{FAULT} + R_E)^2 + (Z_{FAULT} \cdot X_c \cdot R_E)^2} \cdot \sqrt{\left(\frac{1}{R_E}\right)^2 + (X_c)^2}} \quad (4)$$

The highest neutral voltage in low-ohmic grounded neutral point networks is equal to the phase to ground voltage when the fault resistance is zero. The corresponding phase to ground voltage in two sound phases is equal to the line voltage [7].

Table 3 Simulated and calculated results in case of low-ohmic grounded neutral point.

Results	Case A		Case B	
	Simulated	Calculated	Simulated	Calculated
I_{kl} [A]	289,56	293,69	388,30	388,201
Overvoltage	1,72128	1,72958	1,7508	1,72958

5.3. Resonant grounded neutral point

Using formulas 5 and 6 for networks with resonant grounded neutral point single pole fault current and overvoltages when a single pole fault with earth occurs were calculated [7, 12]. Simulated and calculated values are given in table 4.

$$I_{k1} = \frac{U_n \cdot \sqrt{(1)^2 + \left(X_c - \frac{1}{X_L}\right)^2 \cdot (R_{le})^2}}{\sqrt{3} \cdot \sqrt{(Z_{FAULT} + R_{le})^2 + \left(X_c - \frac{1}{X_L}\right)^2 \cdot (R_{le})^2 \cdot (Z_{FAULT})^2}} \quad (5)$$

$$\text{Overvoltage} = \frac{\sqrt{3} \cdot \sqrt{(1)^2 + \left(X_c - \frac{1}{X_L}\right)^2 \cdot (R_{le})^2}}{\sqrt{(Z_{FAULT} + R_{le})^2 + \left(X_c - \frac{1}{X_L}\right)^2 \cdot (R_{le})^2 \cdot (Z_{FAULT})^2} \cdot \sqrt{\left(\frac{1}{R_{le}}\right)^2 + \left(X_c - \frac{1}{X_L}\right)^2}} \quad (6)$$

Table 4 Simulated and calculated results in case of resonant grounded neutral point.

Results	Case A		Case B	
	Simulated	Calculated	Simulated	Calculated
I_{kl} [A]	0,00	$2,10306 \cdot 10^{-7}$	0,00	$2,12511 \cdot 10^{-7}$
Overvoltage	1,73048	1,73205	1,72986	1,73205

5.4. Partial compensation

In case of partial compensation formulas 7 and 8 describe single pole fault current and overvoltages when a single pole fault with earth occurs. Table 5 shows simulated and calculated results in case of partial compensation.

$$I_{kl} = \frac{U_n \cdot \sqrt{\left(1\right)^2 + \left(X_c - \frac{1}{X_L}\right)^2 \cdot (R_E)^2}}{\sqrt{3} \cdot \sqrt{\left(Z_{FAULT} + R_E\right)^2 + \left(X_c - \frac{1}{X_L}\right)^2 \cdot (R_E)^2}} \quad (7)$$

$$\text{Overvoltage} = \frac{\sqrt{3} \cdot \sqrt{\left(1\right)^2 + \left(X_c - \frac{1}{X_L}\right)^2 \cdot (R_E)^2}}{\sqrt{\left(Z_{FAULT} + R_E\right)^2 + \left(X_c - \frac{1}{X_L}\right)^2 \cdot (R_E)^2} \cdot \sqrt{\left(\frac{1}{R_E}\right)^2 + \left(X_c - \frac{1}{X_L}\right)^2}} \quad (8)$$

Table 5 Simulated and calculated results in case of partial compensation.

Results	Case A		Case B	
	Simulated	Calculated	Simulated	Calculated
I_{kl} [A]	289,206	293,617	268,27	268,700
Overvoltage	1,7211	1,72958	1,7082	1,72958

5.5. Analysis of results

As expected, during a single phase earth fault the voltage of the faulted phase collapsed while the voltage of the healthy phases increased. The voltage of the faulted phase for all four transformer neutral point earthing methods behaved as expected. Phase to phase voltage of all three phases for all four methods of transformer neutral point grounding treatment remained unaffected.

Highest overvoltages were expected to occur in case of isolated neutral point and in case of resonant grounded neutral point. In case of low-ohmic grounded neutral point and partial compensation overvoltages were expected to be similar. Results show matching of expected and simulated results. It has been showed that overvoltages strongly depend on the neutral point method. Maximum calculated overvoltage factor (transient overvoltages during an earth fault) in isolated network was 1,7806.

Highest single pole fault current was expected to occur in case of networks with low-ohmic grounded neutral point. Calculated and simulated results show match with expected values. Case B presents network with large number of long cables, and in that case single pole fault current increases. Fault current in case of networks with low-ohmic grounded neutral point increases from 289,56 A to 388,30 due to larger number of long cables. In case of isolated neutral point single pole fault current increases from 6,5761 A to 278,05 A (simulated results). In case of resonant grounded neutral point single pole fault current remains the same (total compensation), as expected.

Increase of the length of the cables does not influence the value of the current in case of the partial compensation, too. Current depends only on the value of the low-ohmic resistor.

The mathematical model gives similar results for single pole fault currents and overvoltages. However, in some events match is not completed. The reasons for that can be because the mathematical model takes into account only capacitive resistance of 35 kV line, and neglects resistance per unit length and inductance per unit length [15]. The Matlab model takes into consideration resistance, inductance and capacitance per unit length [8]. The difference is particularly evident in case B because of a large number of long cables. The aim of the study was to show influence various neutral earthing methods and different length and type of the middle voltage power lines have on overvoltages and fault current magnitudes. For this particular substation observed in paper resonant grounded neutral point is recommended. In that case danger of too high potential (touch voltage) on earth of substation is reduced to minimum (fault current is zero) [5, 13]. When considering single phase to earth faults in medium voltage networks handling safety issues, especially touch voltages, is the most important aspect [2].

Conclusion

The particular analysis presented in this paper is a behavioural comparison of various neutral earthing methods in medium voltage systems in case when a single pole earth fault occurs. This paper has shown the effects the neutral point earthing method and different length and type of the middle voltage power lines have on overvoltages and fault current magnitudes. Longer middle voltage lines (especially long cables) considerably increase fault currents. Overvoltages mainly depend on neutral point earthing method. Recommendation for this particular substation is to use resonant grounded neutral point.

Future work should further investigate the dependence of the amplitudes of the currents and of the overvoltages in case of a single pole earth fault on the neutral point method combined with voltage level, the value of fault resistance and effect it has regarding the distance between the supply busbars and the fault location. The model described in this paper can be used in order to present what particular kind of neutral earthing method to use in specific substation.

References

- [1] V. Komen, R. Čučić: Fault resistances in medium voltage distribution networks, *Annals of DAAAM & Proceedings*, DAAAM International Vienna, 2007.
- [2] O. Siirto, M. Loukkahti, M. Hyvarinen, P. Heine, M. Lehtonen: Neutral point treatment and earth fault suppression, *IEEE Electric Power Quality and Supply Reliability Conference*, Tartu, Estonia, 2012.
- [3] Mathworks, Accelerating the pace of engineering and science, <http://www.mathworks.com/products/simpower/>, 3.7.2014.
- [4] D. Frankovic, A. Marusic: Neural voltage and current dependency on fault impedance value in medium voltage networks, *Annals of DAAAM & Proceedings*, DAAAM International Vienna, 2005.
- [5] R. Čučić, V. Komen, M. Živić Đurović: Neutral point concept in distribution networks, *Engineering Review*, 28-2, 77-89, 2008.
- [6] P. Šarga, D. Hroncová, M. Čurillaa, A. Gmitterko: Simulation of electrical system using Bond Graphs and MATLAB/Simulink, *Procedia Engineering*, 48, 656 – 664, 2012.
- [7] S. Hänninen, Single phase earth faults in high impedance grounded networks, Characteristics, indication and location, disertation for the degree of doctor of technology, Helsinki University of Technology, Espoo, Finland, 2001.
- [8] Y. Chun-wen, W. Ming-hui, J. Liting, L. Ling-ling: MATLAB Power System Simulation of Resonant Grounding Fault, *Energy Procedia*, 17, 1761-1768, 2012.
- [9] I. G. Kuliš, A. Marušić, G. Leci, Protection relay software models in interaction with power system simulators, *MIPRO*, Opatija, 2012.
- [10] Application Guidelines - Overvoltage Protection: Dimensioning, testing and application of metal oxide surge arresters in medium voltage systems; ABB; 4th revised and expanded edition; Wetingen; 2009.
- [11] Medium voltage power cables for rated voltage up to 36 kV, Elka, <http://elka.hr/en/proizvodi/>, July 2014.
- [12] I. G. Kuliš, A. Marušić, S. Žutobradić: Insufficiency of Wattmetric Protection in Resonant Grounded Networks, *Proceedings of the 8th International Conference on Developments in Power System Protection (DPSP)*, Amsterdam, 486-489, 2004.
- [13] J. Pinto, M. Louro, P. Diass: Speed versus sensitivity in earth fault protection regarding human safety in aerial mv networks, *CIREN*, 19th International Conference on Electricity Distribution, Vienna, 2007.
- [14] Q. Zi-boa, G. Weia, Z. Ying-conga: The development of electric arc fault simulation test device, *Procedia Engineering*, 29, 452 – 455, 2012.
- [15] N. Zawania, J. Imrana, M. Faizuhara: Modelling of 132kV Overhead Transmission Lines by Using ATP/EMTP for Shielding Failure Pattern Recognition, *Procedia Engineering*, 53, 278 – 287, 2013.